

FEATURE

- Ceramic brazing sealed technology guarantees no risk of arc leaking and ensures no fire or explosion
- Filled with gas (mostly hydrogen) to minimize contact oxidation and damage from arcing; contact resistance is low and stable; contact part can meet IP67 protection level.
- current 250A continuously at 85°C
- Insulation resistance is 1000MΩ(1000Vd.c.), and dielectric strength between the coil and contacts is 2.6kV, which meets the requirements of IEC 60664-1
- Resistance to high levels of short circuit:10000A



APPLICATION

New energy vehicle , Charging point, Photovoltaic , Energy storage , Industrial power

CONTACT DATA

Contact Arrangement	1 Form A
Contact Resistance	≤125 mV at 250 A
Rated Load Current	250 A (@ 60 mm ² wire)
Rated Switching Voltage	450 Vd.c. or 750 Vd.c.
Rated Switching Power	112.5kW(450Vd.c.)or187.5kW(750Vd.c.)
Min. Applicable Load	6 Vd.c., 1 A
Max. Switching Voltage	1000 Vd.c.
Max. Switching Power	187.5kW(750 Vd.c.)
Max. Breaking Current	3000 A (500 Vd.c.) 1op

CHARACTERISTICS

Dielectric strength	Between coil & contacts	2600 Va.c 1 min
	Between open contacts	2600 Va.c 1 min
Insulation resistance		1000 MΩ at 1000 Vd.c.
Operate time(at nomi. volt.)		≤30 ms
Release time (at nomi. volt.)		≤10 ms
Vibration resistance		10Hz~500Hz, 49 m/s ²
Shock resistance	Functional	Functional Open:98 m/s ² ; Functional Close:196 m/s ²
	Destructive	490 m/s ²
Ambient temperature		-40℃~85℃
Humidity		5% RH ~85% RH
Termination		M6Screw terminal male
Mounting		M5Screw
Unit weight		Approx.420g
Outline Dimensions		Standard Type: 84.5mmx42.5mmx74.5mm
		Horizontal Type: 61.5mmx42.5mmx74.0mm

Notes: Above is the initial vale in the room temperature

COIL

Coil power W	Nominal Voltage Vd.c.	Pick-up Voltage Vd.c.	Drop-out Voltage Vd.c.
6	12	≤9	≥1
	24	≤18	≥2

Notes: The values above are conservative values within the temperature range(-40℃ to 85℃),

ENDURANCE

Project	450 Vd.c.	750 Vd.c.
Electrical Endurance	Making:7.5×10 ⁴ ops (20 Vd.c. ,150A)	Making:7.5×10 ⁴ ops(20 Vd.c. ,150A)
	Switching:2000ops (450 Vd.c. ,250A)	Switching:1000ops (750 Vd.c. ,250A)
	Switching:2000ops (450 Vd.c. ,-250A)	Switching:1000ops (750 Vd.c. ,-250A)
	Breaking:0.06s on 1op (500 Vd.c. ,3000A)	Breaking:0.06s on 1 op (750 Vd.c. ,2500A)
Short Circuit Current	500Vd.c. 10000A ts5ms (No Smoke, no Fire)	
	250A, Cont.	
Current Endurance	350A, 8min	
	500A, 2min	
	900A, 25s	
	1000A, 20s	
Mechanical endurance	2x10 ⁵ ops, on-off ratio:0.6s:5.4s	

Notes: (1) Until special statement, the temperature of electrical endurance is at 23℃ and the on-off ratio is 0.6s:5.4s.

ORDERING INFORMATION

CHEV	-1	12	H	250		-1	C	1	H	, xxx
Product Series: CHEV										
Contact Arrangement: 1:1 Form A										
Nominal Voltage: 12:12Vd.c. 24:24Vd.c.										
Sub-series: H: H Series										
Load Current: 250:250A										
Base Type W:W Type										
Load Voltage: 1: 450Vd.c. 2: 750Vd.c.										
Coil Termination : C:Connector										
Termination : 1:Screw Terminal Female										
Installation Type: H:Horizontal Type										
Extra numbers or letters: Blank or Other Customer Requirements										

Notes: The customer special requirement express as special code after evaluating by Churod.

OUTLINE DIMENSIONS

CHEV-1XXH250W-XC1H

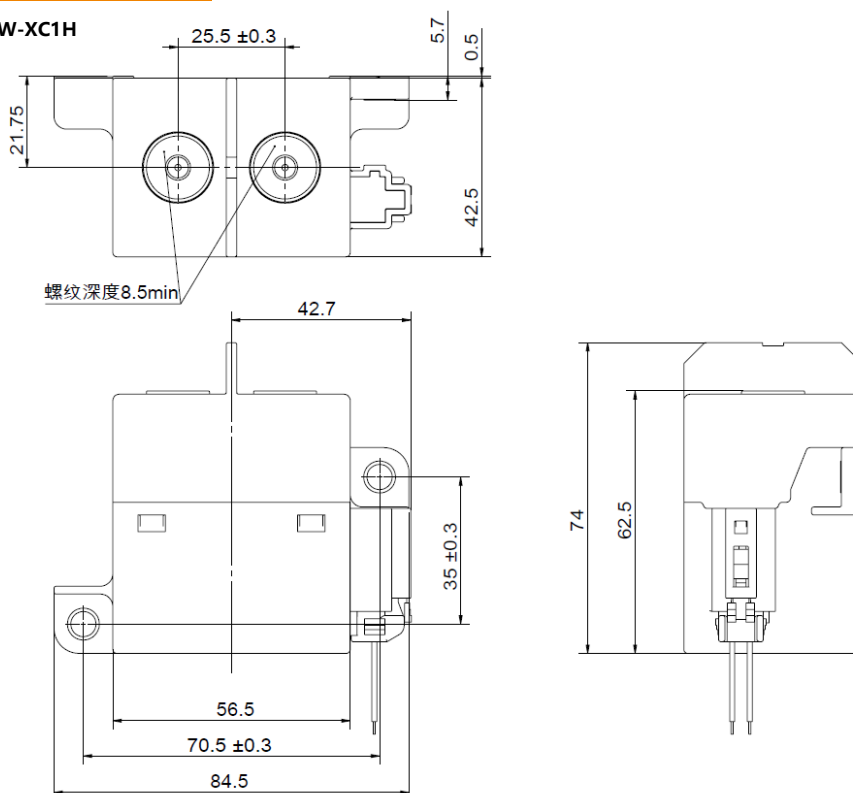

Remark: in case of no tolerance shown in outline dimension: outline dimension ≤ 10 mm: tolerance should be ± 0.3 mm, outline dimension > 10 mm and ≤ 50 mm, tolerance should be ± 0.5 mm, outline dimension > 50 mm, tolerance should be ± 0.8 mm.

WIRING DIAGRAM

Wiring diagram
C: connector (tianhai:0435308)

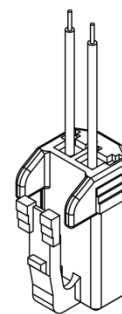
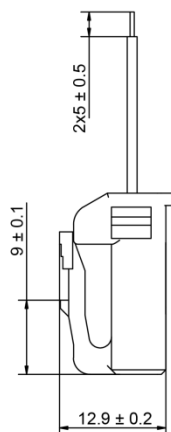
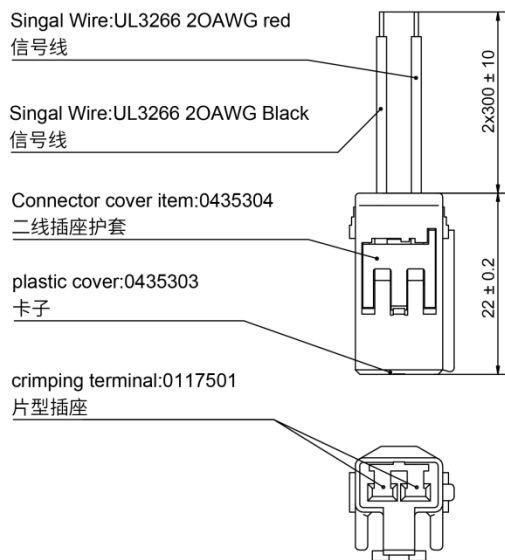

Note: With female connector:
配母端连接器

Tianhai: 0435308 or Yazaki: 7283-1020
天海:0435308或矢崎:7283-1020

INSTALLATION HOLE SIZE 、 WIRING DIAGRAM

Installation Hole

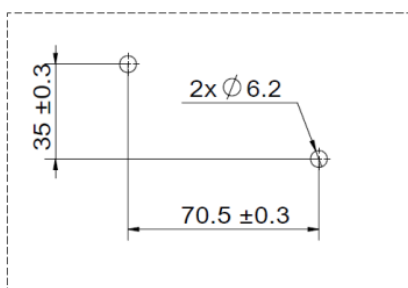

CHEV-1XXH250W-XC1H

Wiring Diagram

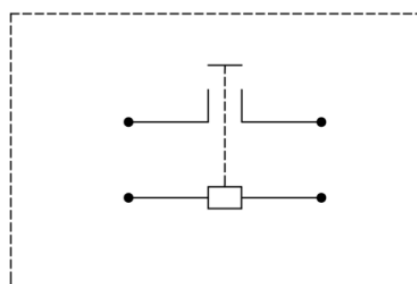

Note: No polarity on the load and coil

INSTALLATION INFORMATION

Load Terminal Installation				
Installation Mode	Selection Screw	Torque	Copper Busbar Diameter	Copper Busbar Thickness
M6 Screw	M6×12 Combined Bolt	6N·m ~8N·m	φ 6.0 ~6.5 mm	2.0 ~3.0 mm

Relay Installation	
Installation Mode	Torque
M5 Screw	3N·m ~4N·m

Combined Bolt Drawing
(Optional)

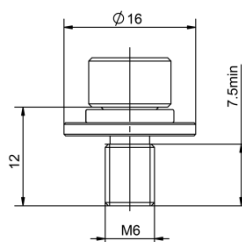

Note:

- In order to prevent loosening, please use the washer when installing the relay.
- Please avoid grease and other foreign matter in the terminal, please use the connecting wire with a cross section area $\geq 60\text{mm}^2$, or they may cause abnormal heating in the terminal part.

DISCLAIMER

The specification is for reference only. See to "Terminology and Guidelines" for more information. Specifications subject to change within notice. We could not evaluate all the performance and all the parameters for every possible application. Thus the user should be in a right position to choose the suitable product for their own application. If there is any query. Please contact Churod for the technical service. However, it is the user's responsibility to determine which product should be used only.